

Data sheet

# Safety relief valves

## Type SFV 20-25



SFV 20 - 25 are standard, **back pressure dependent** safety relief valves in angle-way execution, specially designed for protection of vessels and other components against excessive pressure.

The valve is designed to meet the strict quality demands and safety requirements for refrigeration installations, specified by the international classification societies.

The valve is recommended as an external and internal safety relief valve in refrigeration plants. The spring housing is closed tightly to avoid refrigerant leakage.

The inlet flow diameters of the valves are:

- 18 mm ( $\frac{3}{4}$  in.) for SFV 20, and
- 23 mm (1 in.) for SFV 25

The valves can be delivered with set pressures between 10 and 25 bar g (145 and 363 psi g).

Standard pressure setting valves having "TÜV Pressure Setting Certificate" with each valve, are also available.

### Features

- Applicable for the refrigerants HCFC, HFC, R717 (Ammonia), R744 (CO<sub>2</sub>) within a temperature range of -30°C/+100°C (-22°F/+212°F).
- Classification: DNV, CRN, BV, EAC etc. To get an updated list of certification on the products please contact your local Danfoss Sales Company.

### Technical data

- **Refrigerants**  
Applicable for the refrigerants HCFC, HFC, R717 (Ammonia), R744 (CO<sub>2</sub>) within a temperature range of -30°C/+100°C (-22°F/+212°F).  
Flammable hydrocarbons are not recommended.  
For further information please contact your local Danfoss Sales Company.
- **Pressure**  
Pressure setting range: 10 - 25 bar g (145 - 363 psi g). For further information please contact your local Danfoss Sales Company.  
  
The valves are designed for:  
Strength test:  
43 bar g (624 psi g)  
Leakage safety:  
Same as set pressure
- **Important:** The SFV safety relief valve is dependent on the back pressure (if the back pressure is higher than the atmospheric pressure, the opening pressure will be higher than stated set pressure).  
  
Special circumstances such as vibrations (which should be avoided) and oscillating pressure may require an increased difference between the operational pressure and the closing pressure.
- **Pressure setting**  
The operating pressure of the plant should be at least 15% below the set pressure. This allows a perfect re-seating of the safety relief valve after having been activated.
- **Temperature range** -  
30/+100°C (-22/+212°F)



*Pressure Equipment Directive (PED)*

The SFV-valves are approved in accordance with the European standard specified in the Pressure Equipment Directive and are CE marked. For further details / restrictions - see Installation Instruction

SFV valves		
Nominal bore	18 mm (0.709 in.)	23 mm (0.906 in.)
Classified for	Fluid group I	
Category	IV	

**Design**

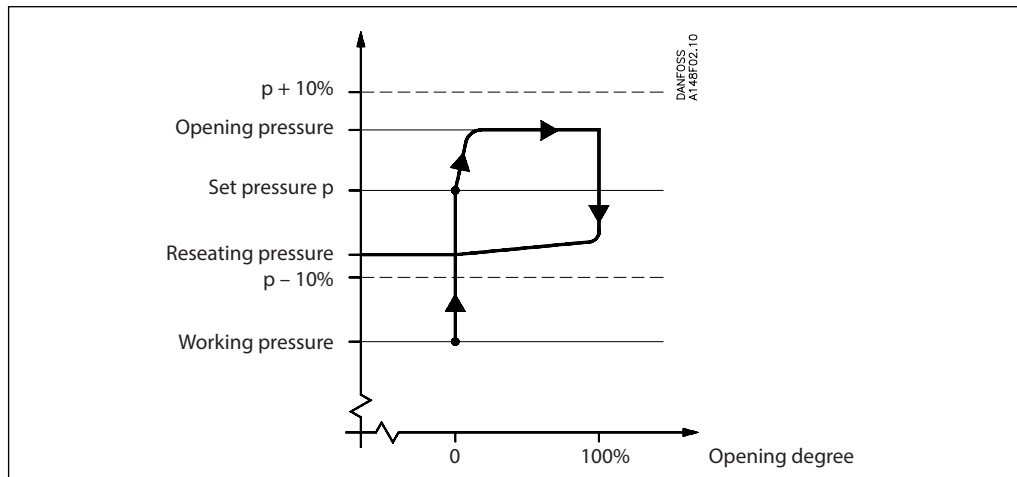

SFV is designed as a **standard safety relief valve** (DIN 3320), which are recommended for refrigeration plants. On a rise in pressure above the set pressure, the safety relief valve will initially start opening slightly, to minimise the outlet of

refrigerant. If the pressure continues to increase, the valve will open fully. The safety relief valve will be fully open before the pressure is 10% higher than set pressure, and fully closed before the pressure is 10% below set pressure.

*Connections*

Available with the following connections:

- Outside pipe thread T (ISO 228/1)
- Welding fittings (DIN 2448)

*Housing*

Made of special steel approved for low temperature operation. Spindle and seat are made of stainless steel, to ensure precise operation even during extraordinary conditions. The gasket of the valve cone is made of a special chloroprene (neoprene) compound.

*Installation*

To ensure exact operation of the safety relief valve it should be installed with the spring housing upwards. If the valve is mounted as an internal safety relief valve without any demand for exact opening pressure, the valve may be fitted with the spring housing in other positions. When the valve is mounted, it is important to avoid the influence of static, dynamic and thermal stress.

A very precise technique has been applied for the production of the seal. However, this seal can still be damaged, if dirt is blown from the pipe system into the valve.

It is recommended that safety relief valves exhaust into the open air with a U-pipe filled with oil on the discharge branch, to prevent dirt from penetrating into the valve. It is also recommended that the valves be installed in pairs in conjunction with the double stop valve type DSV. For further information please see the DSV data sheet.

*Re-calibration/servicing*

In certain countries the authorities demand that the valves are checked at least once a year (see local rules).

*Control/identification*

After adjustment of the set pressure at Danfoss, the valves are sealed. For that reason Danfoss can only guarantee correct operation, as long as the seal remains unbroken.

All valves are provided with a metal plate with the following information:

- Flow diameter
- Set pressure
- Date of production
- Production number
- Type approved code.

*Transport/Handling*

The valves are fitted with special protection covers and packed into purpose made transportation cartons.

It is important the cover remains fitted around the valve until it is installed.

*To ensure the exact and precise operation of the valve it must be handled with care.*

**Capacity**

The design and construction of the safety relief valve has been tested and approved by TÜV. This test comprises control of the function of the valve as well as measuring of the capacity, which is the basis of the curves and tables on the following pages. The values in the table are based on saturated gas.

If e.g. back pressure or superheated gas have to be taken into consideration, the formulas or the Danfoss computation program (DIRcalc™) can be used.

*Table 1.*

Valve	Nominal size		Flow diameter $d_o$	Flow area $A_o$	De-rated, certified coefficient of discharge $K_{dr}$
	Inlet	Outlet			
SFV 20	20 mm	25 mm	18 mm	254 mm <sup>2</sup>	0.54
	¾ in.	1 in.	0.709 in.	0.394 in <sup>2</sup>	
SFV 25	25 mm	32 mm	23 mm	415 mm <sup>2</sup>	0.48
	1 in.	1¼	0.906 in.	0.643 in <sup>2</sup>	

The discharge capacity of the safety relief valves are based on (ISO 4126-1 / prEN 1313 6 (1998)).

$$q_m = 0.2883 \times C \times A_o \times K_{dr} \times K_b \sqrt{p}$$

$q_m$  Discharge capacity (kg/h)

$C$  Discharge function depending of the actual refrigerant ( $\kappa$ ) see table 2 (-)

$A_o$  Flow area of the safety relief valve (mm<sup>2</sup>).

$K_{dr}$  De-rated coefficient of discharge ( $K_{dr} = K_d \times 0.9$ ), (the  $K_{dr}$  is certified by TÜV) see table 1 (-)

$K_b$  Correction factor for sub-critical flow. (-)

$K_b = 1.0$  when the back pressure is lower than approx.  $0.5 \times$  relieving pressure ( $P_b < 0.5 \times p$ )

For all SFV safety valves  $K_b = 1.0$

$v$  Specific volume of the vapour at the relieving pressure  $p$ . (m<sup>3</sup>/kg)

$p_{set}$  Set pressure, the predetermined pressure at which a pressure relief valve under operation starts to open ( $p_{set}$  is indicated on the metal plate on the safety relief valve).  
(bar gauge)

$p_{atm}$  Atmospheric pressure. (1 bar)

$p$  Relieving pressure,  $p = p_{set} \times 1.1 + P_{atm}$  (bar absolute)

For further details see the above-mentioned ISO or EN standards.

*Table 2. Properties of Refrigerants*

Refrigerant	Isentropic exponent $\kappa$	Discharge function $C$
R22	1.17	2.54
R134a	1.12	2.50
R404A	1.12	2.49
R410A	1.17	2.54
R717 (Ammonia)	1.31	2.64
R744 (CO <sub>2</sub> )	1.30	2.63
Air	1.40	2.70

Capacity  
(cont.)

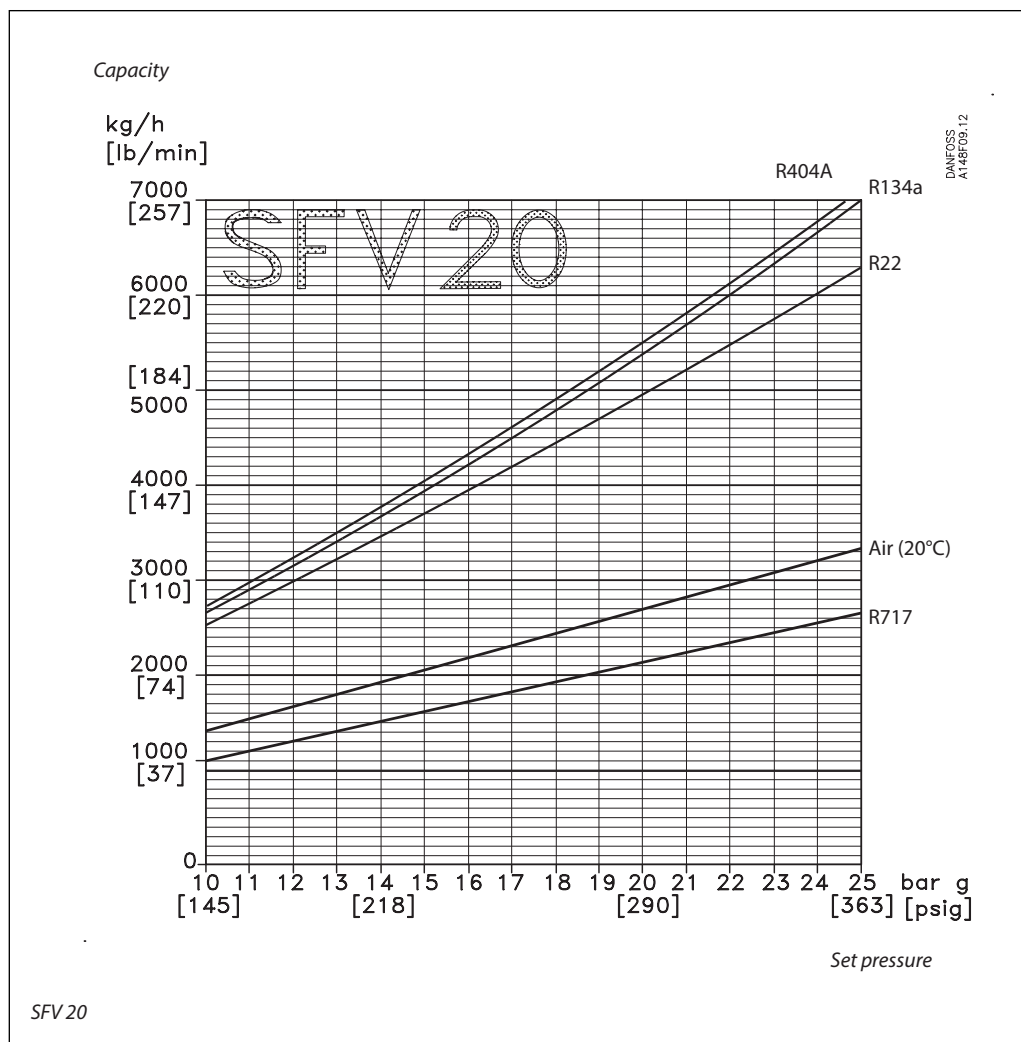

Capacity

Set pressure		R22	R134a	R404A	R717	Air (20°C)
13 bar g 189 psi g	kg/h lb/min	3220 118	3430 126	3500 129	1415 52	1790 66
18 bar g 261 psi g	kg/h lb/min	4440 163	4800 176	4900 180	1925 71	2435 89
21 bar g 305 psi g	kg/h lb/min	5215 192	5680 209	5770 212	2235 82	2820 104
25 bar g 363 psi g	kg/h lb/min	6285 231	6980 257	7125 262	2660 98	3335 122

SFV 20

Capacity  
(cont.)

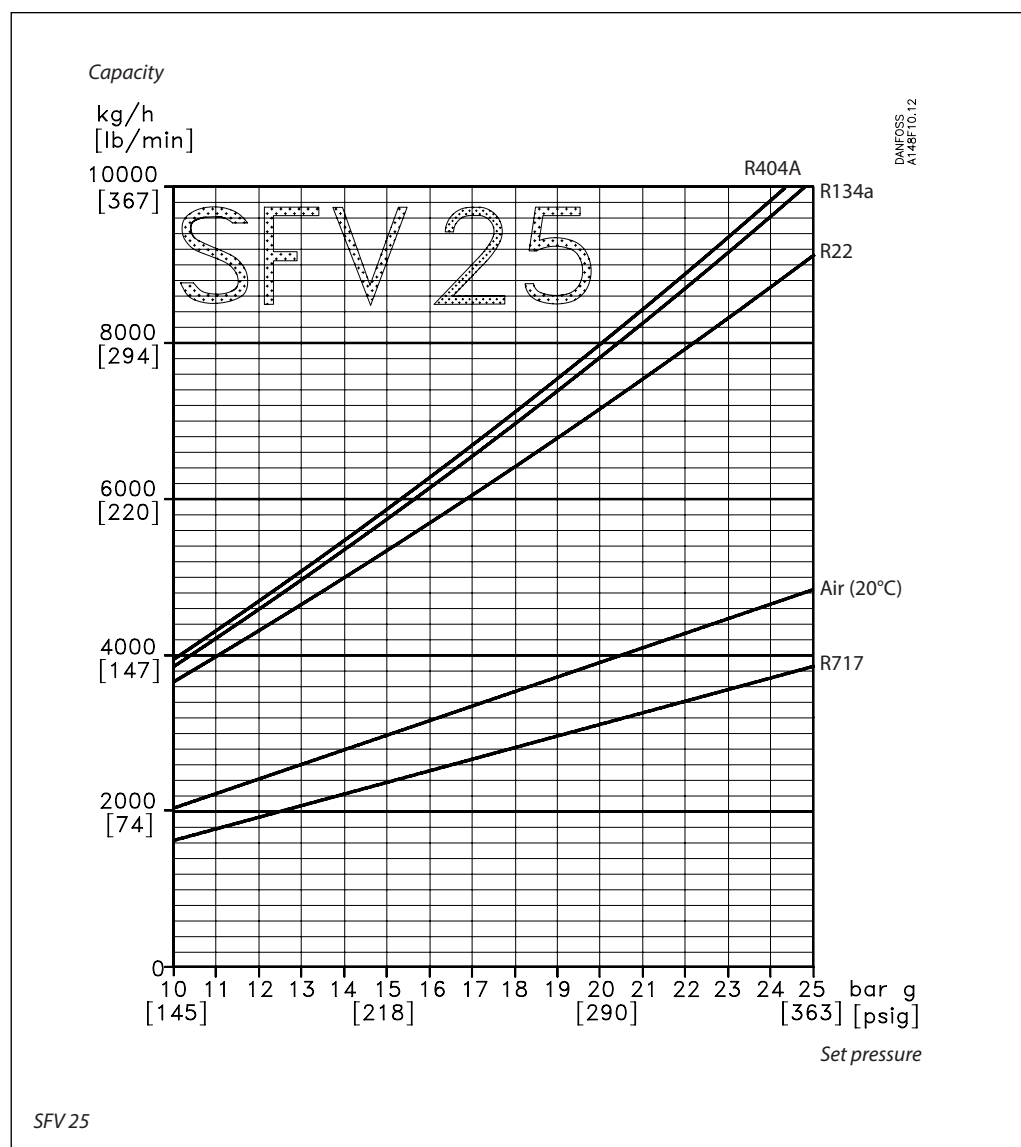

Capacity

Set pressure		R22	R134a	R404A	R717	Air (20°C)
SFV 25						
13 bar g	kg/h	4670	4980	5075	2050	2600
189 psi g	lb/min	172	183	186	75	96
18 bar g	kg/h	6445	6965	7115	2790	3530
261 psi g	lb/min	237	256	261	103	130
21 bar g	kg/h	7565	8240	8370	3240	4090
305 psi g	lb/min	278	303	308	119	150
25 bar g	kg/h	9120	10135	10340	3860	4835
363 psi g	lb/min	335	372	380	142	178

Material specification

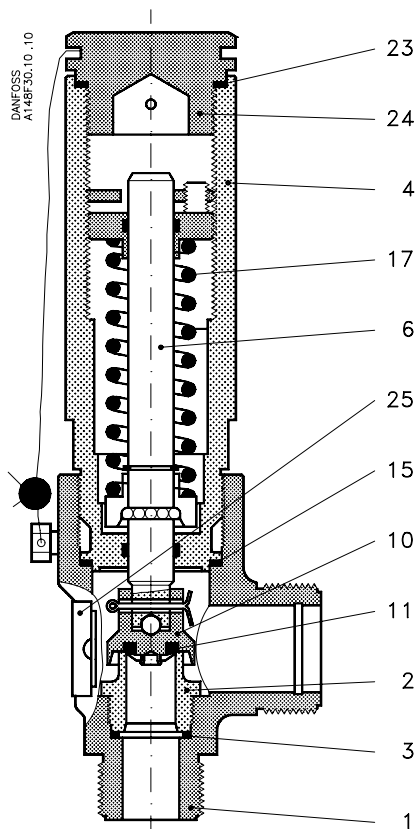

No.	Part	Material	DIN	ISO	ASTM
1	Housing	Steel	G20Mn5 QT *P285QH *TTSt35N	TW 6, 2604/3-75	Grade 1, A333, A334 * A350 LF2
2	Valve seat	Stainless steel	X10CrNiS189, 17440	Type 17, 683/13	AISI 303
3	Packing washer	Aluminium *Non-asbestos gasket			
4	Valve top	Steel	St. 37.2, 1652	Fe 360 B, 660	Grade C, A 283
6	Valve spindle	Stainless steel	X10CrNiS189, 17440	Type 17, 683/13	AISI 303
10	Valve cone	Steel			
11	Valve cone seal	Cloroprene (Neoprene)			
15	Packing washer	Aluminium *Non-asbestos gasket			
17	Spring	Steel	Class C	A 679, 17223	
23	Packing washer	Aluminium *Non-asbestos gasket			
24	Plug	Steel	9S Mn28, 1651 *R St 37.2, 17100	Type 2, R 683 Fe 360 B, 630	Grade C, A 283
25	Marking label	Aluminium			

\* Alternative material

## Data sheet | Safety relief valves, type SFV 20-25

### Connections

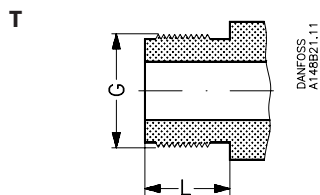

Size mm	Size in.	Inlet	Outlet	L mm	L in.		
---------	----------	-------	--------	------	-------	--	--

*T outside pipe thread, (ISO 228/1)*

20	3/4	G 1 1/4	G 1 1/2	20	0.79		
25	1	G 1 1/4	G 1 1/2	20	0.79		

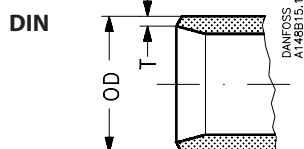

Size mm	Size in.	Inlet (mm)		Inlet (in.)		Outlet (mm)		Outlet (in.)			
		OD	T	OD	T	OD	T	OD	T		

*Welding fittings DIN (2448)*

20	3/4	26.9	2.3	1.059	0.091	33.7	2.6	1.337	0.102		
25	1	33.7	2.6	1.327	0.102	42.4	2.6	1.669	0.102		

### Dimensions and weights

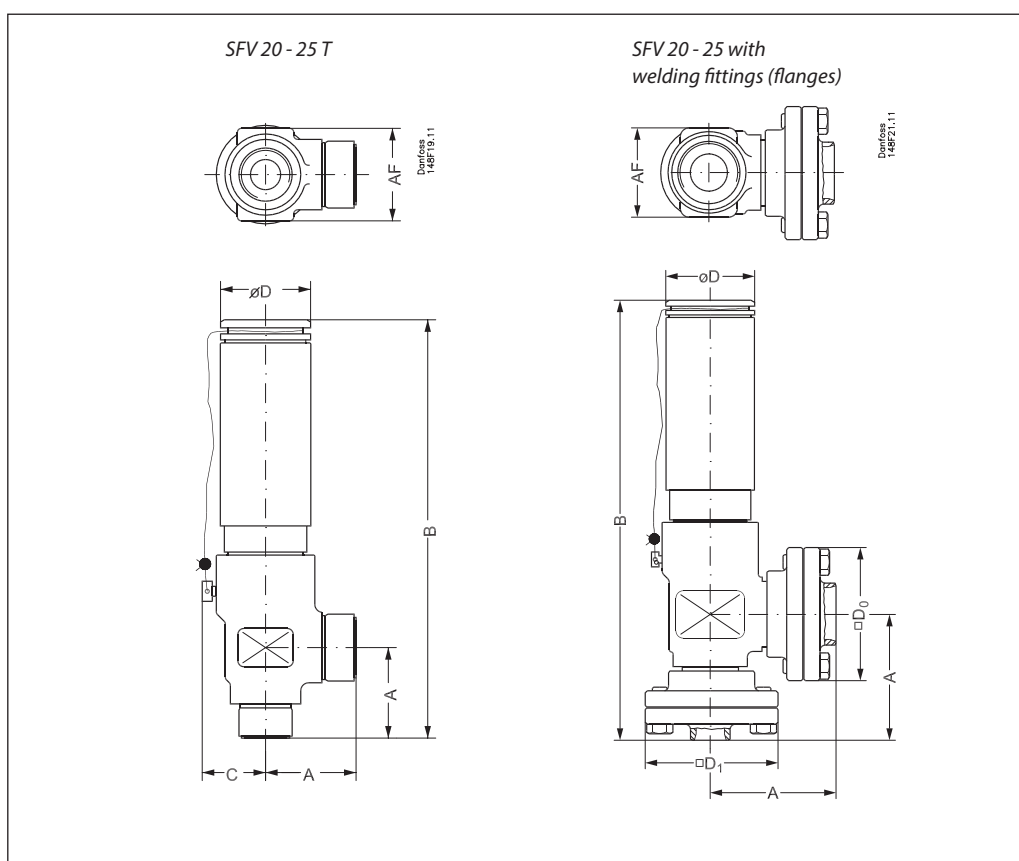

Valve size		A	B	C	□ D <sub>0</sub>	øD	□ D <sub>1</sub>	AF	Weight
------------	--	---	---	---	------------------	----	------------------	----	--------

*SFV 20 - 25 T, with threaded connections ISO 228/1 pipe threads*

SFV 20 (3/4 in.)	mm in.	55 2.17	270 10.63	40 1.57		60 2.36		60 2.36	4.2 kg
SFV 25 (1 in.)	mm in.	55 2.17	270 10.63	40 1.57		60 2.36		60 2.36	4.2 kg

*SFV with welding fittings, DIN 2448*

SFV 20 (3/4 in.)	mm in.	85 3.35	300 11.81		90 3.54	60 2.36	90 3.54	60 2.36	6.0 kg
SFV 25 (1 in.)	mm in.	85 3.35	300 11.81		90 3.54	60 2.36	90 3.54	60 2.36	6.0 kg

Specified weights are approximate values only.

**Ordering**
*How to order*

The table below is used to identify the valve required.

Please note that the type codes only serve to identify the valves, some of which may not form part of the standard product range. For further information please contact your local Danfoss Sales Company.

*Example for type codes*

<b>SFV 20 T 210</b>
---------------------

*Type codes*

Valve type	SFV	Safety relief valve	
Nominal size in mm  (valve size measured on the connection diameter)	<b>20</b> <b>25</b>	Available connections T      DIN welding fitting	
		DN 20	×      ×
		DN 25	×      ×
Connections	<b>T</b>	Outside threaded connections: ISO 228/1 Pipe thread - The welding fittings for single mounted safety relief valve must be ordered separately	
Pressure setting		<i>Standard pressure setting: 2××</i>	
			<i>SFV 20    SFV 25</i>
	<b>210</b>	10 bar g (145 psi g)	×      ×
	<b>211</b>	11 bar g (160 psi g)	×      ×
	<b>212</b>	12 bar g (174 psi g)	×      ×
	<b>213</b>	13 bar g (188 psi g)	×      ×
	<b>214</b>	14 bar g (203 psi g)	×      ×
	<b>215</b>	15 bar g (218 psi g)	×      ×
	<b>216</b>	16 bar g (232 psi g)	×      ×
	<b>217</b>	17 bar g (247 psi g)	×      ×
	<b>218</b>	18 bar g (261 psi g)	×      ×
	<b>219</b>	19 bar g (276 psi g)	×      ×
	<b>220</b>	20 bar g (290 psi g)	×      ×
	<b>221</b>	21 bar g (305 psi g)	×      ×
	<b>222</b>	22 bar g (319 psi g)	×      ×
	<b>223</b>	23 bar g (334 psi g)	×      ×
	<b>224</b>	24 bar g (348 psi g)	×      ×
	<b>225</b>	25 bar g (363 psi g)	×      ×
		<i>Standard pressure setting with TÜV certificate: 3××</i>	
			<i>SFV 20    SFV 25</i>
	<b>310</b>	10 bar g (145 psi g)	×      ×
	<b>311</b>	11 bar g (160 psi g)	×      ×
	<b>312</b>	12 bar g (174 psi g)	×      ×
	<b>313</b>	13 bar g (188 psi g)	×      ×
	<b>314</b>	14 bar g (203 psi g)	×      ×
	<b>315</b>	15 bar g (218 psi g)	×      ×
	<b>316</b>	16 bar g (232 psi g)	×      ×
	<b>317</b>	17 bar g (247 psi g)	×      ×
	<b>318</b>	18 bar g (261 psi g)	×      ×
	<b>319</b>	19 bar g (276 psi g)	×      ×
	<b>320</b>	20 bar g (290 psi g)	×      ×
	<b>321</b>	21 bar g (304 psi g)	×      ×
	<b>322</b>	22 bar g (319 psi g)	×      ×
	<b>323</b>	23 bar g (334 psi g)	×      ×
	<b>324</b>	24 bar g (348 psi g)	×      ×
	<b>325</b>	25 bar g (362 psi g)	×      ×

**Important!**

Where products need to be certified according to specific certification societies, the relevant information should be included at the time of order.



**Ordering**  
(cont.)

*Certified SFV valves with standard set pressure*

Size		Construction and test facilities are approved by TÜV		
mm	in.	Type	Bar g (psi g)	Part no.
20	3/4	SFV20 T 210	10 (145)	<b>2416+254</b>
20	3/4	SFV20 T 211	11 (160)	<b>2416+255</b>
20	3/4	SFV20 T 212	12 (174)	<b>2416+256</b>
20	3/4	SFV20 T 213	13 (189)	<b>2416+150</b>
20	3/4	SFV20 T 214	14 (203)	<b>2416+257</b>
20	3/4	SFV20 T 215	15 (218)	<b>2416+258</b>
20	3/4	SFV20 T 216	16 (232)	<b>2416+259</b>
20	3/4	SFV20 T 217	17 (247)	<b>2416+260</b>
20	3/4	SFV20 T 218	18 (261)	<b>2416+151</b>
20	3/4	SFV20 T 219	19 (276)	<b>2416+261</b>
20	3/4	SFV20 T 220	20 (290)	<b>2416+262</b>
20	3/4	SFV20 T 221	21 (305)	<b>2416+152</b>
20	3/4	SFV20 T 222	22 (319)	<b>2416+241</b>
20	3/4	SFV20 T 223	23 (334)	<b>2416+263</b>
20	3/4	SFV20 T 224	24 (348)	<b>2416+264</b>
20	3/4	SFV20 T 225	25 (363)	<b>2416+183</b>

*Certified SFV valves with standard set pressure and TÜV pressure setting certificate with each valve*

Size		Each valve is certified by a representative from TÜV		
mm	in.	Type	Bar g (psi g)	Part no.
20	3/4	SFV20 T 310	10 (145)	<b>2416+285</b>
20	3/4	SFV20 T 311	11 (160)	<b>2416+286</b>
20	3/4	SFV20 T 312	12 (174)	<b>2416+287</b>
20	3/4	SFV20 T 313	13 (189)	<b>2416+160</b>
20	3/4	SFV20 T 314	14 (203)	<b>2416+288</b>
20	3/4	SFV20 T 315	15 (218)	<b>2416+289</b>
20	3/4	SFV20 T 316	16 (232)	<b>2416+290</b>
20	3/4	SFV20 T 317	17 (247)	<b>2416+291</b>
20	3/4	SFV20 T 318	18 (261)	<b>2416+161</b>
20	3/4	SFV20 T 319	19 (276)	<b>2416+292</b>
20	3/4	SFV20 T 320	20 (290)	<b>2416+293</b>
20	3/4	SFV20 T 321	21 (305)	<b>2416+162</b>
20	3/4	SFV20 T 322	22 (319)	<b>2416+294</b>
20	3/4	SFV20 T 323	23 (334)	<b>2416+295</b>
20	3/4	SFV20 T 324	24 (348)	<b>2416+296</b>
20	3/4	SFV20 T 325	25 (363)	<b>2416+186</b>

*Certified SFV valves with standard set pressure*

Size		Construction and test facilities are approved by TÜV		
mm	in.	Type	Bar g (psi g)	Part no.
25	1	SFV25 T 210	10 (145)	<b>2416+265</b>
25	1	SFV25 T 211	11 (160)	<b>2416+266</b>
25	1	SFV25 T 212	12 (174)	<b>2416+267</b>
25	1	SFV25 T 213	13 (189)	<b>2416+153</b>
25	1	SFV25 T 214	14 (203)	<b>2416+268</b>
25	1	SFV25 T 215	15 (218)	<b>2416+269</b>
25	1	SFV25 T 216	16 (232)	<b>2416+270</b>
25	1	SFV25 T 217	17 (247)	<b>2416+271</b>
25	1	SFV25 T 218	18 (261)	<b>2416+154</b>
25	1	SFV25 T 219	19 (276)	<b>2416+272</b>
25	1	SFV25 T 220	20 (290)	<b>2416+273</b>
25	1	SFV25 T 221	21 (305)	<b>2416+155</b>
25	1	SFV25 T 222	22 (319)	<b>2416+242</b>
25	1	SFV25 T 223	23 (334)	<b>2416+274</b>
25	1	SFV25 T 224	24 (348)	<b>2416+275</b>
25	1	SFV25 T 225	25 (363)	<b>2416+184</b>

*Certified SFV valves with standard set pressure and TÜV pressure setting certificate with each valve*

Size		Each valve is certified by a representative from TÜV		
mm	in.	Type	Bar g (psi g)	Part no.
25	1	SFV25 T 310	10 (145)	<b>2416+297</b>
25	1	SFV25 T 311	11 (160)	<b>2416+298</b>
25	1	SFV25 T 312	12 (174)	<b>2416+299</b>
25	1	SFV25 T 313	13 (189)	<b>2416+163</b>
25	1	SFV25 T 314	14 (203)	<b>2416+300</b>
25	1	SFV25 T 315	15 (218)	<b>2416+301</b>
25	1	SFV25 T 316	16 (232)	<b>2416+302</b>
25	1	SFV25 T 317	17 (247)	<b>2416+303</b>
25	1	SFV25 T 318	18 (261)	<b>2416+164</b>
25	1	SFV25 T 319	19 (276)	<b>2416+304</b>
25	1	SFV25 T 320	20 (290)	<b>2416+305</b>
25	1	SFV25 T 321	21 (305)	<b>2416+165</b>
25	1	SFV25 T 322	22 (319)	<b>2416+306</b>
25	1	SFV25 T 323	23 (334)	<b>2416+307</b>
25	1	SFV25 T 324	24 (348)	<b>2416+308</b>
25	1	SFV25 T 325	25 (363)	<b>2416+187</b>

*Flanges and gaskets*

Type	Code No.
Flanges + gaskets set for SFV 20	<b>148F3020</b>
Flanges + gaskets set for SFV 25	<b>148F3021</b>

*Repair kit*

Type	Code No.
Repair kit for SFV 20 (gaskets and cone)	<b>2453+082</b>
Repair kit for SFV 25 (gaskets and cone)	<b>2453+083</b>

ENGINEERING  
TOMORROW

*Danfoss*

---

Danfoss can accept no responsibility for possible errors in catalogues, brochures and other printed material. Danfoss reserves the right to alter its products without notice. This also applies to products already on order provided that such alterations can be made without subsequential changes being necessary in specifications already agreed. All trademarks in this material are property of the respective companies. Danfoss and the Danfoss logotype are trademarks of Danfoss A/S. All rights reserved.